



Jennie

Basic Series Locomotive



Owners Handbook

For the Jennie locomotive

Operating Instructions

IMPORTANT:

Read these instructions carefully before operating the locomotive.

The following items are required for running this engine and are not included with the model.

<u>Fuel</u>	Butane or Butane/Propane gas. See 'Filling the gas tank'
<u>Water</u>	See 'Filling the boiler'
<u>Lubricating oil</u>	See 'Lubrication'

SAFETY PRECAUTIONS

This is a working model locomotive using steam under pressure and highly flammable fuel. Provided it is operated with reasonable care and attention, no problems should arise.

It is intended for use out of doors and must only be operated in a well ventilated area.

Whilst the locomotive is in use, hot gasses are exhausted up the chimney and excess steam frequently blows off through the safety valve even when stationary, so operator and spectators should not bend over the model. As you will appreciate, this is not a toy and is therefore unsuitable for young unsupervised children.

Follow manufacturer's recommendations regarding the safe storage of gas canisters.

Some areas of the model will get quite hot whilst it is operating so be aware of this and take extra care when handling or operating the locomotive. Always have to hand either a fire extinguisher or wet cloth when operating the model.

Jennie Instruction Booklet

CONTENTS

Tool kit	Page 4
Running in	Page 4
Identification of parts of the locomotive	Page 5
Preparations for operation	Page 6
1. Filling the Gas Tank	Page 6
2. Filling the Boiler	Page 7
3. Lubrication	Page 8
4. Lighting the Burner	Page 9
Driving the locomotive	Page 10
Storage between operating sessions	Page 12
Trouble shooting & maintenance.	Page 13
Steam Leaks.	Page 14
Gas System.	Page 14
Boiler and Gas Tank Certificate, (<i>EC Declaration Of Conformity</i>).	Pages 17 & 18
Service and Parts.	Page 20

TOOL KIT

The following items are included with your locomotive.

One small bottle of special steam oil for use in the lubricator.

One 60ml syringe with plastic tube for filling the boiler with water.

One spare gas jet.

One set of spare washers and 'O' rings.

One Allen key for cylinder socket cap screws.

RUNNING IN

All locomotives are test run before leaving the factory, but will require several hours of running in, when new, to overcome initial tightness and allow valves etc. to 'bed in'. The locomotive will waste a proportion of its water and steam until 'run in' due to leaking slide valves, a tendency to prime more, and simply overcoming the initial tightness of the moving parts. Take note in the 'Lighting the burner' section regarding this matter.

As the model heats up and cools down each time you raise steam, screws and nuts have a tendency to stretch and loosen a little so you will also need to make regular checks and 'nip up' any that become loose. Most are quite visible and easy to get to however if there is any steam leaking from the valve chests on top of the cylinder or front cylinder covers, refer to the Trouble Shooting section.

Note: - When steam has been raised and you are ready to run, it is advisable to connect a heavy truck or flat wagon with a weight (up to 20lbs) for the locomotive to pull. The design of the model is such that when the boiler is initially full of water, opening the regulator may allow water to pass through the steam regulator. As this reaches the superheater, the water will flash into steam causing the locomotive to accelerate rapidly. An alternative method is to initially run the locomotive on blocks or a 'rolling road'.

After 5 minutes the water level in the boiler will have reduced and the model can be run light, if desired.

When the locomotive is fully bedded in, this tendency will lessen.

IDENTIFICATION OF PARTS OF THE LOCOMOTIVE

1/ Steam regulator. 2/ Gas regulator.
3/ Gas filler valve. 4/ Gas burner.

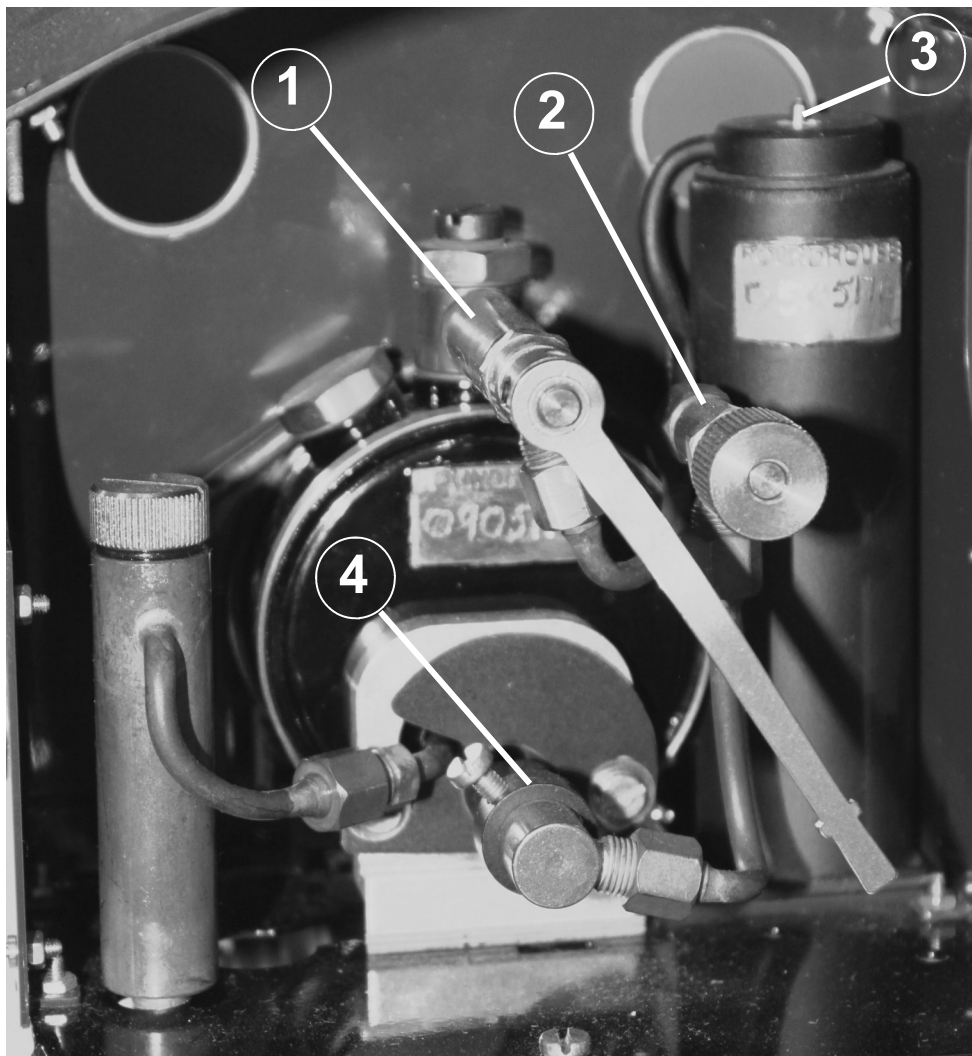

PREPARING FOR OPERATION

The locomotive must be serviced before being operated. It is important to perform all the following operations.

1) FILLING THE GAS TANK

The filling of the gas tank should only be carried out in a well-ventilated area, where there are no naked lights or other lighted locomotives close by. Ordinary Butane or Iso-butane gas (as used in gas cigarette lighters) is the preferred fuel, though for economy, the larger canisters as used for blowlamps or camping stoves etc. are better. The larger canisters have an EN417 threaded self sealing valve on top and require a special adapter to couple up to the filler valve on the locomotive. A special brass gas filler adapter is obtainable from your local garden railway supplier or direct from **ROUNDHOUSE**.

Mixed gasses are also available and may be used if ordinary butane or iso-butane are not available, but see 'Gas System' on page 14 for more information on this subject.

Before attempting to fill the gas tank, make sure that the gas control valve is closed by turning it clockwise.

The filler valve for the gas tank is on top of the tank under the cab roof. Invert the gas canister and place its nozzle over the gas filler valve. Support the tank from underneath and press the canister down. The gas will be heard hissing as it enters the tank and a small amount will escape around the valve. This is quite normal and is the tank venting as the liquid enters.

After about 20 to 30 seconds, liquid gas will emerge from the valve showing that the tank is full. Remove the canister immediately.

2) FILLING THE BOILER

The boiler is filled with water through the safety valve bush, housed

on top of the boiler. Remove the safety valve by unscrewing it using the knurled ring at its base. Fill the boiler right to the top with clean water. Distilled water is recommended if available. As an alternative to distilled water if this is unavailable, clean tap water can be used in soft water areas. Also, rain water or water from a dehumidifier can be used provided that it is adequately filtered

Do not use de-ionised water as this type of water may cause long term damage to the boiler and fittings.

There has to be a space above the water to allow steam to be raised so, insert the end of the plastic pipe into the boiler and withdraw 30ml of water with the syringe. Replace the safety valve finger tight.

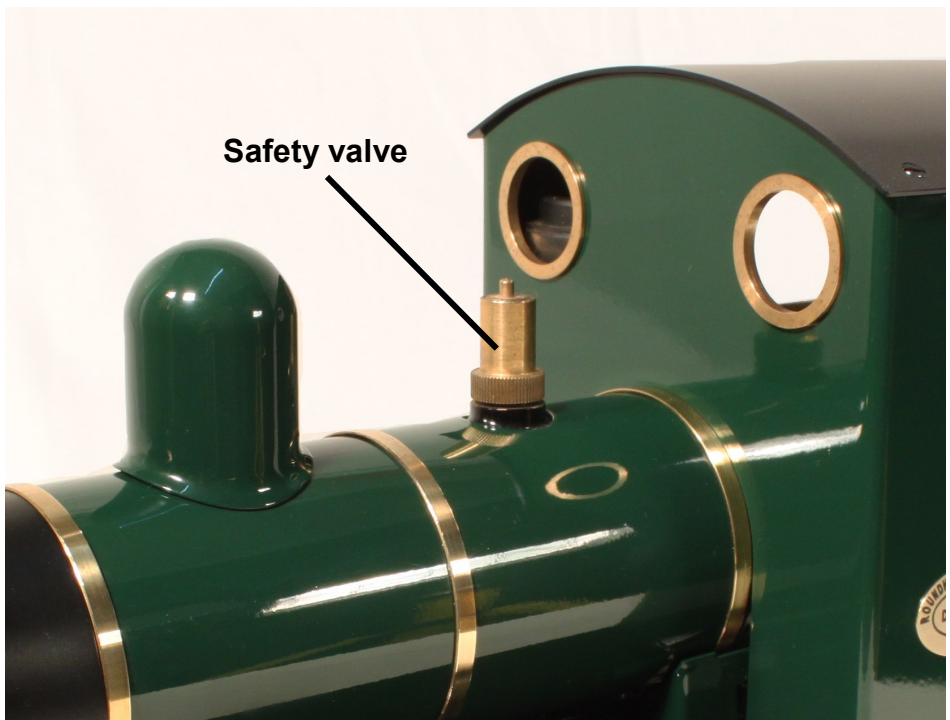

3) LUBRICATION

Regular lubrication of all working parts is important and should be carried out before each operating session. There are two types of lubrication required: The external moving linkages and bearings are lubricated with a medium oil such as motor engine oil, and the internal steam mechanisms such as cylinders, pistons and valves are lubricated with a special steam oil that is mixed with the steam. Infrequent external lubrication will allow parts to run dry, and over oiling can form pools around operating parts that attract dirt and grit. If too thin an oil is used it will evaporate very quickly as the loco gets hot – leading to dry running. We recommend the use of a 20-50 motor oil for external lubrication.

The slip eccentric valve gear is located between the rear wheels and the frames and is lubricated by running oil down the back of the wheels. Internal lubrication is achieved by steam oil that is mixed with the steam in the displacement lubricator, housed in the left-hand side of the cab. Remove the knurled cap from the top of the lubricator. Locate the knurled lubricator drain screw located under the cab floor. Unscrew this two or three turns, but do not remove it. Any water in the lubricator will run out through the hole in the drain screw. When the water has finished draining, tighten the drain screw and refill the lubricator from the top with the steam oil supplied.

Lubricator cap

**Lubricator drain
screw**

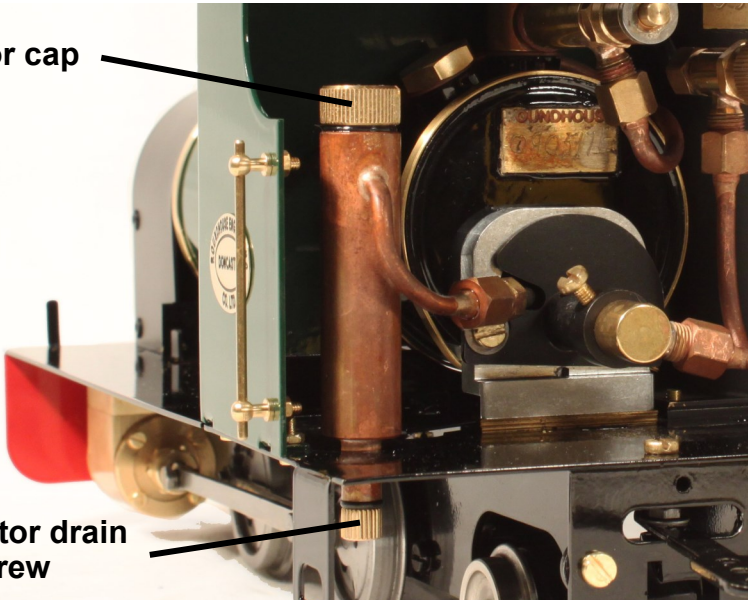

Replace the cap. Take time filling the lubricator, especially when cold, as the oil takes time to run down and may trap an air bubble. Both cap and drain screw are fitted with 'O' rings and need only be closed finger tight.

NOTE: Only special steam oil as supplied should be used in the lubricator and under no circumstances should ordinary oil be substituted, or damage may result. The gas and steam regulators will require periodic lubrication – see the troubleshooting section for details.

4) LIGHTING THE BURNER

WARNING: Before lighting read the section on gas system troubleshooting and be aware of potential problems. If the gas system is not operating correctly, **shut it off immediately** or damage may result.

After filling the gas tank, move the locomotive to another location before lighting. Butane is heavier than air and small pockets of gas can collect around the locomotive during filling. To light the burner, hold a lighted match or cigarette lighter over the top of the chimney and **slowly** open the gas regulator by turning it anti-clockwise. The gas should ignite almost immediately with a pop as the flame travels down the chimney and into the boiler tube. The burner should be audible but not too loud.

NOTE as stated above, the gas regulator should be opened slowly until the burner ignites. If opened too quickly, particularly when the engine is cold or if the gas tank has just been filled, it is possible that the flame may not travel back into the boiler flue but stay in the smokebox. If this should happen, the burner will sound quite different to normal and the blue flame will be visible in the smokebox if viewed down the chimney from a safe height. Should this happen, turn off the gas immediately or damage may result, and then re-light it. If the problem persists, and it is not possible to ignite the burner correctly, then refer to gas system troubleshooting. For the first couple of minutes keep the burner on low. This is important, as until it warms up, the flame will be a little unstable and turning it up too much could cause it to go out. Also,

with a completely full tank, liquid gas could be drawn off instead of vaporised gas, which can also extinguish the flame. After a couple of minutes, the gas control valve can be opened more to speed up steam raising. Open the gas regulator slowly to about one full turn. The full range of adjustment (closed to fully open) is achieved within the **first full rotation** of the gas regulator knob any more is unnecessary. .

When full working pressure has been reached (about 40psi), the safety valve will start to blow off steam, this can take up to 10 or 12 minutes in outdoor locations. Steam generation can be controlled by the gas valve in the cab. If the safety valve blows off frequently during running, then too much steam is being produced, which wastes water and gas. Turning down the burner will decrease the amount of steam made. Conversely, if steam pressure is not maintained during a run, then the burner should be turned up. The art of balancing steam generation to the operational requirement by the adjustment of the gas control valve will quickly be learned. The gas tank has a duration of about 25 minutes, though this will vary a little depending on the gas valve setting.

DRIVING THE LOCOMOTIVE

There are two main controls, both of which are housed in the cab.

- 1) The gas regulator, which should be used to control steam generation as described earlier.
- 2) The steam regulator. This is the main steam control valve and regulates the speed at which the engine will run. The regulator handle is situated in the right hand cab doorway and is moved anti-clockwise to open and clockwise to close.

Select the desired direction of travel by manually moving the locomotive for one wheel revolution in the desired direction and crack open the regulator just a little. Initially, there will be a certain amount of water in the pipes and cylinders which will cause the engine to run jerkily until it is exhausted through the chimney. This is known as priming and is quite normal and will clear after a few moments. If the engine appears to 'lock up' during initial starting from cold, it is often helpful to close the regulator and gently move

the engine manually to expel the excess water from the cylinders then open the regulator just a little to allow a small amount of steam through. It is also helpful to reverse direction of the locomotive with the regulator closed, then open the regulator just a little and run in reverse for a short distance. This may have to be repeated until all water clears but avoid forcing or jerking the engine as this will only aggravate the matter. Gently does it and small regulator openings will ensure the quickest results.

Once the parts have warmed up, the engine will move off steadily and its speed can be controlled with the regulator. Subsequent starts will be quite smooth once the cylinders etc. have reached their normal operating temperature and the water level in the boiler has dropped a little. This tendency to prime will often reduce as the loco becomes 'run in'.

To reverse the locomotive, close the regulator to bring it to a halt, move the engine manually for one wheel revolution in the desired direction and open the regulator again. Take care when holding the engine to reverse it as it will be very hot in places.

The art of fine control will soon be learnt with a little practice.

Once the gas has all been used, the burner will go out and steam pressure will drop until it is so low that the loco will no longer run. When this happens, close both the steam and gas regulators and allow the loco to cool down before preparing for another run. Once it is cool enough to remove the safety valve, refill water, gas and lubricator as previously described ready for the next run.

The boiler should not be allowed to run dry, but as the gas is designed to run out before the water, this should not happen under normal running conditions and if the engine is sufficiently 'run in'.

The gas tank has a duration of about 25 minutes, though this will vary a little depending on gas valve setting. The boiler should not be allowed to run dry, and the gas tank capacity is such that the gas should run out before the water. When the gas is fully used up, the steam pressure in the boiler will gradually drop until the loco comes to a halt. Should the water expire before the gas is fully used, the pressure will drop rapidly and the loco will stop. If this

happens, turn off the gas. No damage will result if the gas is turned off immediately. **Remember, leaving the burner lit under an empty boiler can cause damage.**

For those who would like longer runs, a set of parts is available from **ROUNDHOUSE** to add a water level gauge and water filling system. This allows the boiler to be topped up at any time and maintain a fairly constant water level. The gas tank will still require refilling each time it is empty.

STORAGE BETWEEN OPERATING SESSIONS

At the end of an operating session, it is good practice to clean the locomotive carefully with a clean soft cloth, and to oil all bright metal parts.

- * Do not leave fuel or water in the tank or boiler for long periods.
- * Do not store in places where the temperature may drop below freezing as water may still be present in the pipe work.
- * Ensure all controls are closed.

Periodically it may be necessary to wash off all traces of dirt and old oil from the moving parts with paraffin (not thinners). This will remove any accumulations of dirt or grit. After washing with paraffin, leave to dry thoroughly overnight before re-oiling. It is most important that clean oil is applied and allowed to penetrate fully into all moving parts before the locomotive is run again. Manually moving the locomotive back and forth will assist in distributing the oil fully. Under normal operating conditions this procedure should not be required more than once or twice per year.

TROUBLE SHOOTING & MAINTENANCE

On a working model of this nature, it is important to keep all working parts well lubricated.

With constant heating up, cooling down and the stresses of hard work, screws etc. can work loose particularly over the first few hours of running. It is good practice to check all fixings and cylinder screws regularly but remember, never over tighten.

STEAM LEAKS

The cylinders are fitted with 'O' rings in the glands sealing both piston and valve rods. These can be adjusted with a spanner if steam leaks develop. They should only be tightened just enough to stop the leak, as over tightening will affect the running of the model. Cylinder covers are fitted with gaskets and valve chests with 'O' rings.

A little 'bubbling' of oil may sometimes occur around these and is quite normal; however, steam leaking past the gasket should be attended to. If 'nipping up' retaining screws does not stop a steam leak, a service kit is available which includes replacement gaskets and seals and full instructions for fitting. Steam leaking from the front or rear cylinder covers can be cured by carefully tightening the four screws that hold each one to the cylinder block. These covers are fitted with gaskets. For the front screws, you will need to remove the front buffer beam which is held on by two brass cheese head screws through its front face.

The valve chests are sealed with 'O' rings and tightening the four countersunk retaining screws (but be careful not to over tighten)

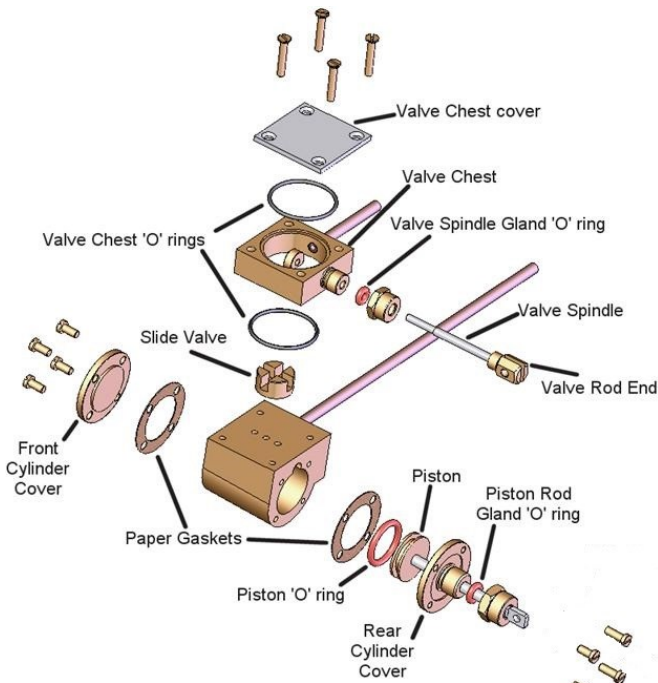

will stop any leaks.

GAS SYSTEM

Locomotives are fitted with our 'FG' type gas burner, which is set up and fully tested at the factory.

This system is designed for use with Butane or Iso-Butane gas. Mixed gasses, i.e. Butane with a proportion of Propane mixed in, are available, and may be used if straight Butane is unavailable. These come in a variety of mixes ranging from 90/10 to 60/40 with one of the most common being 70/30. The figures refer to the proportions of the mix i.e. 70/30 contains 70% butane and 30% propane.

If using mixed gasses, always choose the one with the largest proportion of butane. The addition of propane slightly alters the gasses properties. This can make the burner a little more difficult to light when cold or after filling the gas tank. Always open the regulator very slowly when lighting, and only just sufficient for ignition to take place. Opening too much too soon may extinguish the flame until the burner reaches normal operating temperature.

The tiny jet in these units can become blocked by small particles of dirt making the burner difficult to light, burn weakly at normal operating temperatures*, burn in the smokebox or fail completely. If any of these should happen, clean out the jet as follows.

(* On very cold days, a burner may start off burning weakly due to the temperature of the gas but should increase to its normal level as the engine warms up. This is quite normal)

Carefully, disconnect the gas pipe from the gas jet holder using a 2BA spanner.

Note when connecting or disconnecting the gas pipe and jet block, do not use excessive force. Always hold the end of the gas burner near the air holes to support it otherwise it is possible to cause damage by bending the body. Slacken the screw retaining the gas jet holder and slide it out to the rear. Remove the jet from the gas jet holder using a 4BA spanner.

Wash out the jet in fast evaporating thinner (Cellulose or similar). Blow through the jet from the front, which should clear most blockages. Although the hole through the jet is tiny, if you hold it up to the light you should be able to see quite clearly if it is blocked or not. If in doubt, fit a new jet. A spare gas jet is included with the toolkit.

Do not use wire to clean the jet as this can damage the precision hole and may upset the delicate balance of the gas system. Re-assemble in the reverse order, putting a small amount of PTFE tape round the thread of the jet. Ensure all connections are tight. When re-positioning the gas jet holder in the burner, ensure that it is pushed in as far as it will go.

The gas regulator has a spindle 'O' ring housed inside the body which may need lubrication from time to time if the control becomes 'spongy' in operation, making precise gas control difficult.

As stated in the lighting instructions on page 8, the full range of adjustment for normal burner operation is achieved within the first full rotation of the regulator knob, and it should only be unscrewed more than this for maintenance purposes and when the tank is empty, and there are no naked lights nearby.

To lubricate it, remove the knurled knob which is retained by a M3 socket grub screw (M1.5 AF Allen key required) in the side. Beneath the knob is a back-lash spring and white PTFE washer which will slide off the spindle.

Unscrew the hexagon retaining nut then screw the spindle out of the body.

The 'O' ring can now be lubricated.

Replace the spindle followed by the retaining nut. Slide the white PTFE washer and backlash spring over the spindle and replace the knob. Note that the grub screw that holds the knob in place tightens into a groove near the end of the spindle.

Gas Regulator (Internal Parts)

Regulator
Body



'O' ring to be
lubricated



Hexagon
Retaining
Nut



Back-Lash
Spring



Regulator
Spindle



White PTFE
Washer



Knurled
Knob



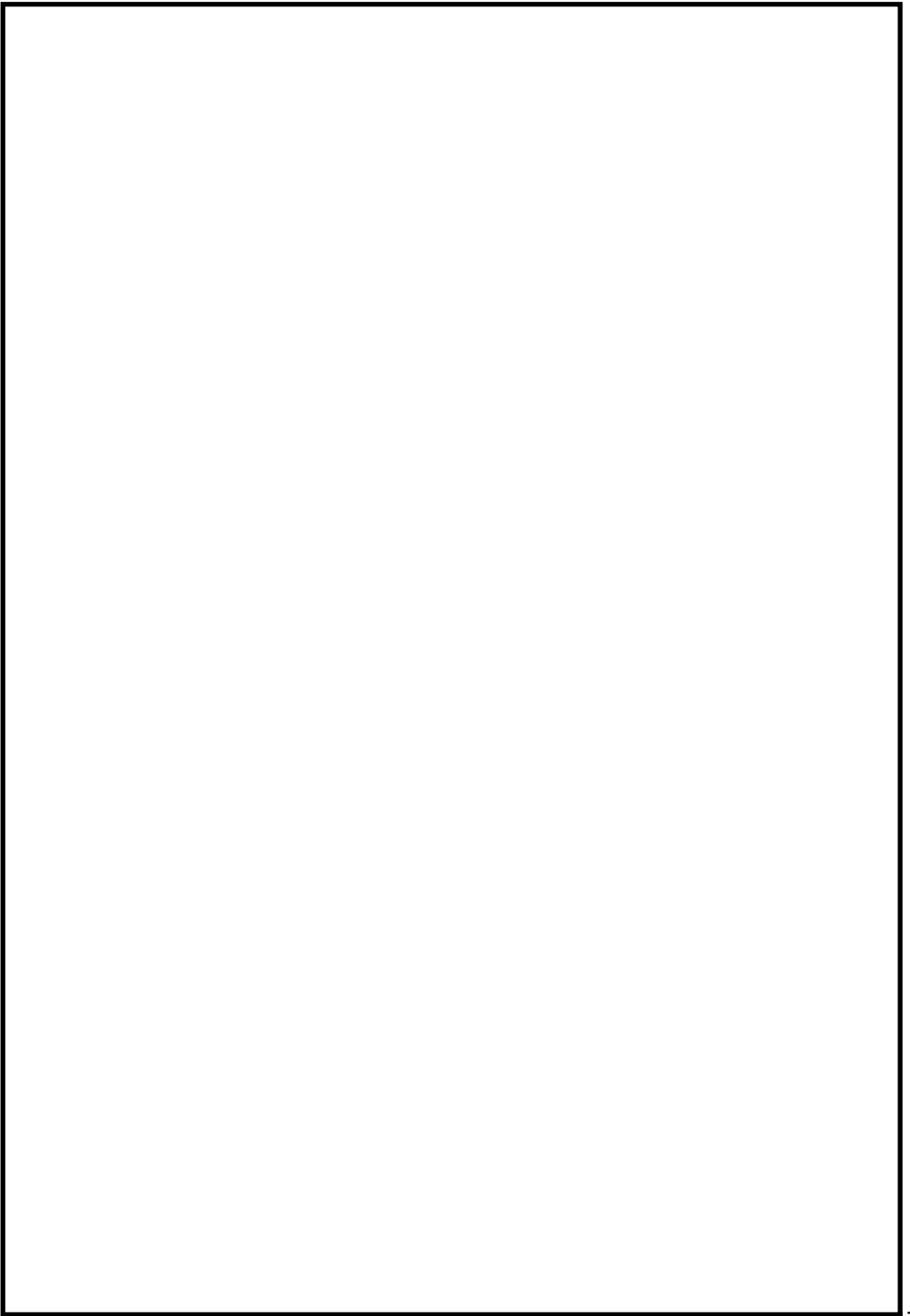

Please refer to the 'owner's handbook' for your particular model of locomotive, for details on correct use of these pressure vessels.

Pressure vessel care and maintenance

Gas tank

The gas tank is used for the storage of LPG (liquefied petroleum gas) in the form of butane, iso-butane or as set out in the 'owners handbook'.

The tank is fitted with a self-venting filler valve which contains no serviceable parts. Should the filler valve become defective in any way, it must be replaced with a new item.

It is recommended that the gas tank should undergo the following checks, carried out by a 'competent person', club, society or pressure vessel manufacturer, every year:-

1/ thorough visual inspection.

And every five to ten years:-

1/ hydrostatic pressure test to not less than 1.5 and not more than 2 times the maximum working pressure.

Boiler

The boiler is fitted with a safety valve to prevent the steam pressure rising above the maximum allowable working pressure. This is pre-set to open at between 2.38 bar (35 psi) and 2.72 bar (40 psi) and must not be adjusted to increase this value.

If the safety valve becomes defective in any way, it should be replaced or returned to the factory for service and calibration.

It is recommended that the boiler should undergo the following checks, carried out by a 'competent person', club, society, or pressure vessel manufacturer, every one to two years:-

1/ thorough visual inspection.

2/ hydrostatic pressure test to not less than 1.5 and not more than 2 times the maximum working pressure.

3/ steam test to check the correct functioning of all steam controls, gauge and safety valve.

Gas Burner

- 1). Superheater Pipe.
- 2). Lubricator Pipe.
- 3). Gas Jet Holder retaining screw.
- 4). Gas Jet.
- 5). Gas Jet Holder.
- 6). Gas Pipe.
- 7). Gas Burner fixing screw.
- 8). Air Inlet Holes.

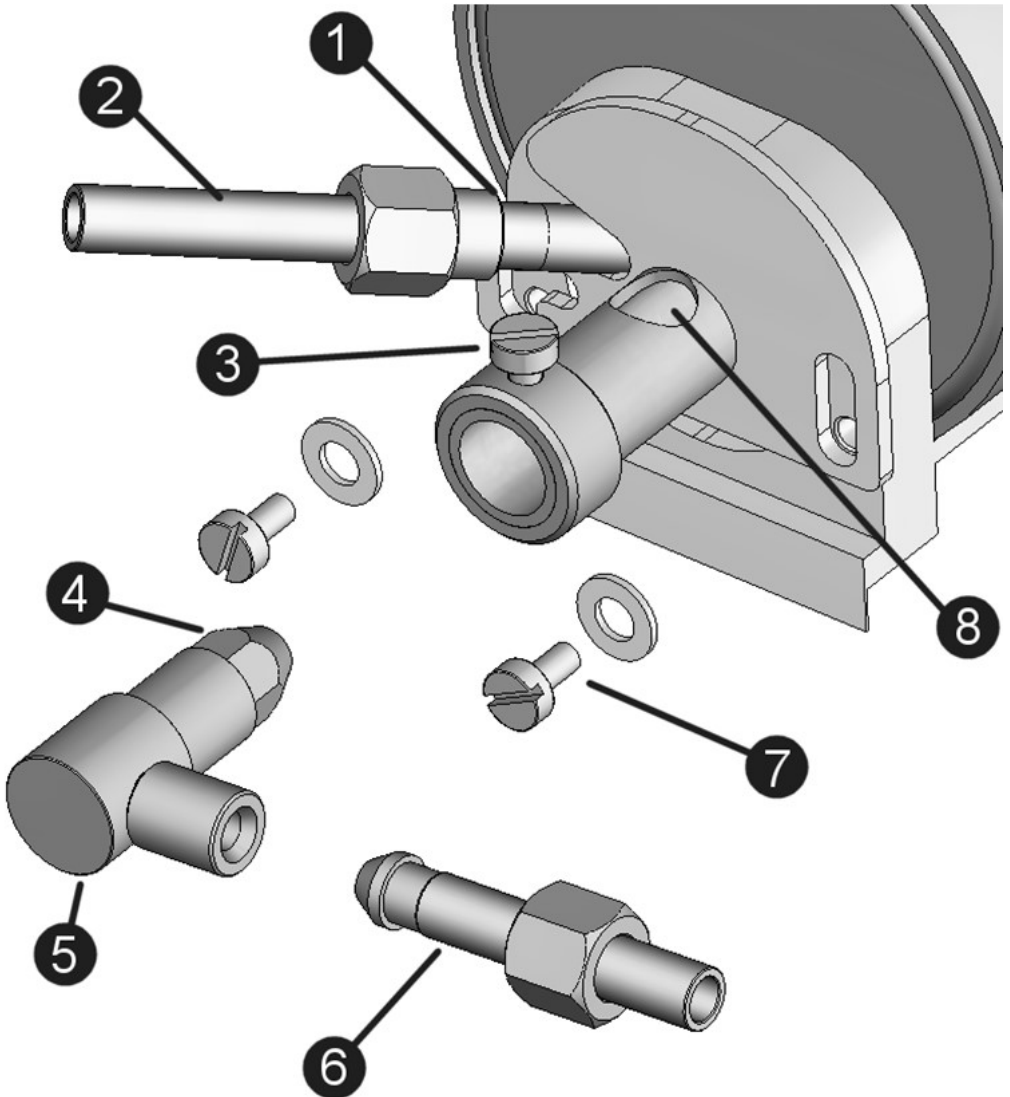

SERVICE AND PARTS

If any problems arise with this model which are not covered in these operating instructions or, spare parts are required, owners should first contact their local dealer. Your **ROUNDHOUSE** dealer is;

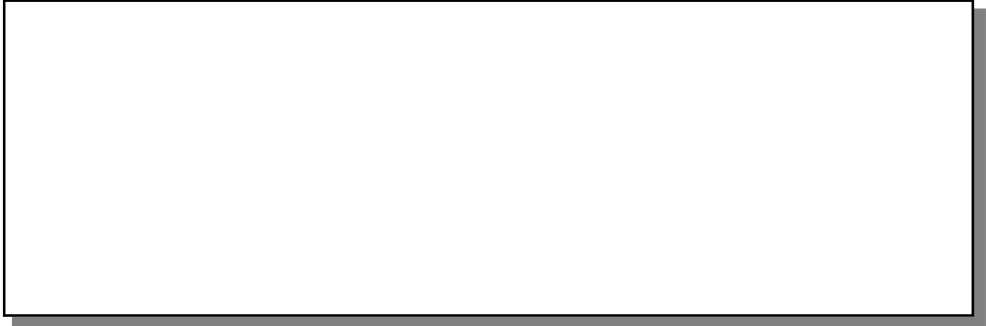

If your dealer is unable to help, you may contact the Factory directly;

ROUNDHOUSE ENGINEERING CO. LTD.
Units 6-10 Churchill Business Park. Churchill Road.
Wheatley. Doncaster. DN1 2TF. England
Telephone 01302 328035 Fax 01302 761312
e-mail: support@roundhouse-eng.com

www.roundhouse-eng.com